

Wandmontage

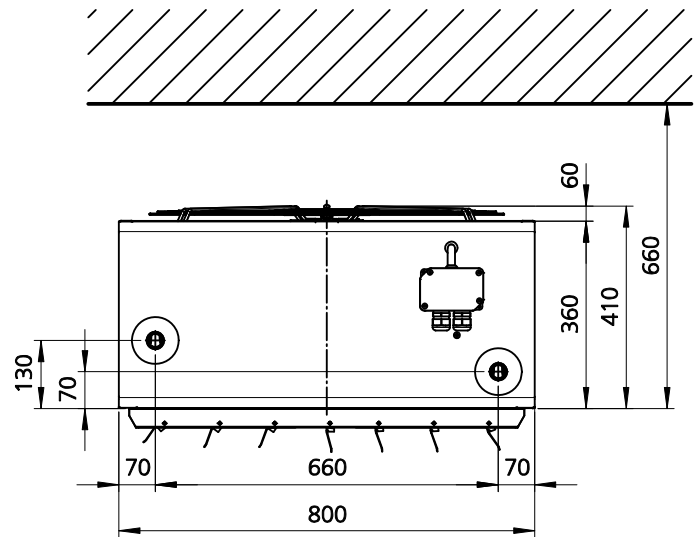

Deckenmontage

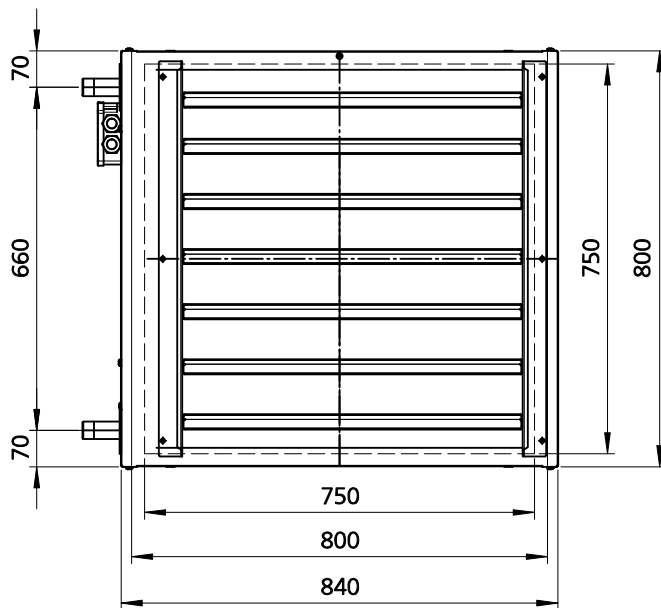

Vorderansicht

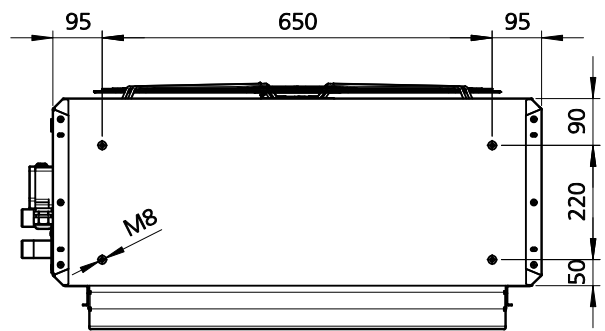

Befestigungsbohrungen

Gewindeanschluss 1 1/2"

				Datum	Name	Format	Art-Gr.	Version	CAD-Nr.	
				Bearb.	29.07.09	4	157	1	447693	
				Freig.						
				 49794 Lingen (Ems) Tel. (0591) 7108-0 · Fax 7108-300 eMail: info@kampmann.de Internet: www.kampmann.de			Abmessungen			
							Lufferhitzer Tip Typ 57			
				Angeb.-Nr.			Ansichten			
				Auftr.-Nr.			WT Cu/Al			
Index	Änderung	Datum	Name	Zul.Abw.	ISO 2768-m	Bereich	Konstruk	Maßstab	1:18	Blatt